

Knight Watch Security

Design Overview

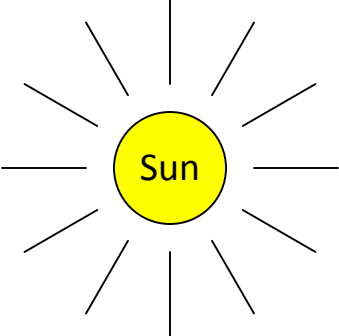

Custom Made PV Pannels

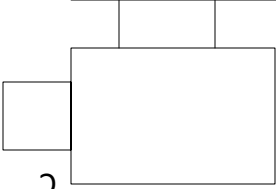
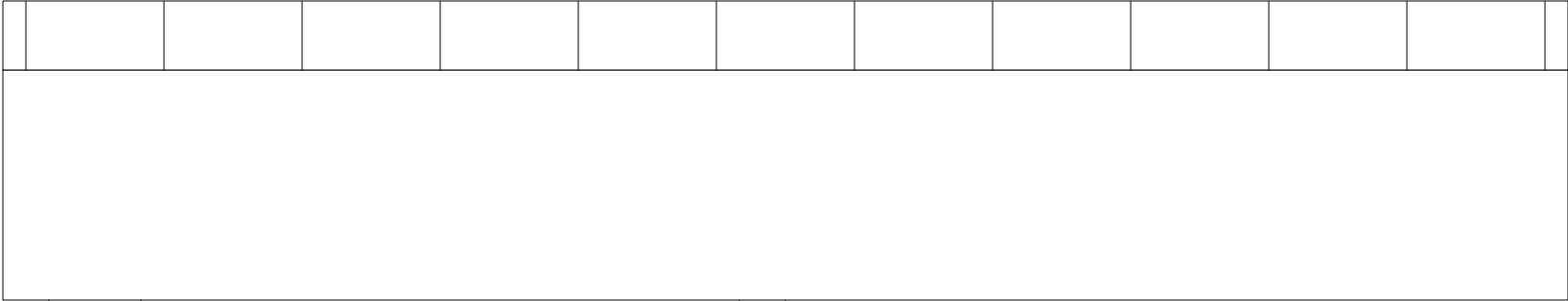

Security Camera



Pole

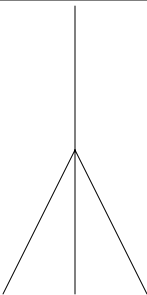

Wifi
Antenna

Network Interface and Control

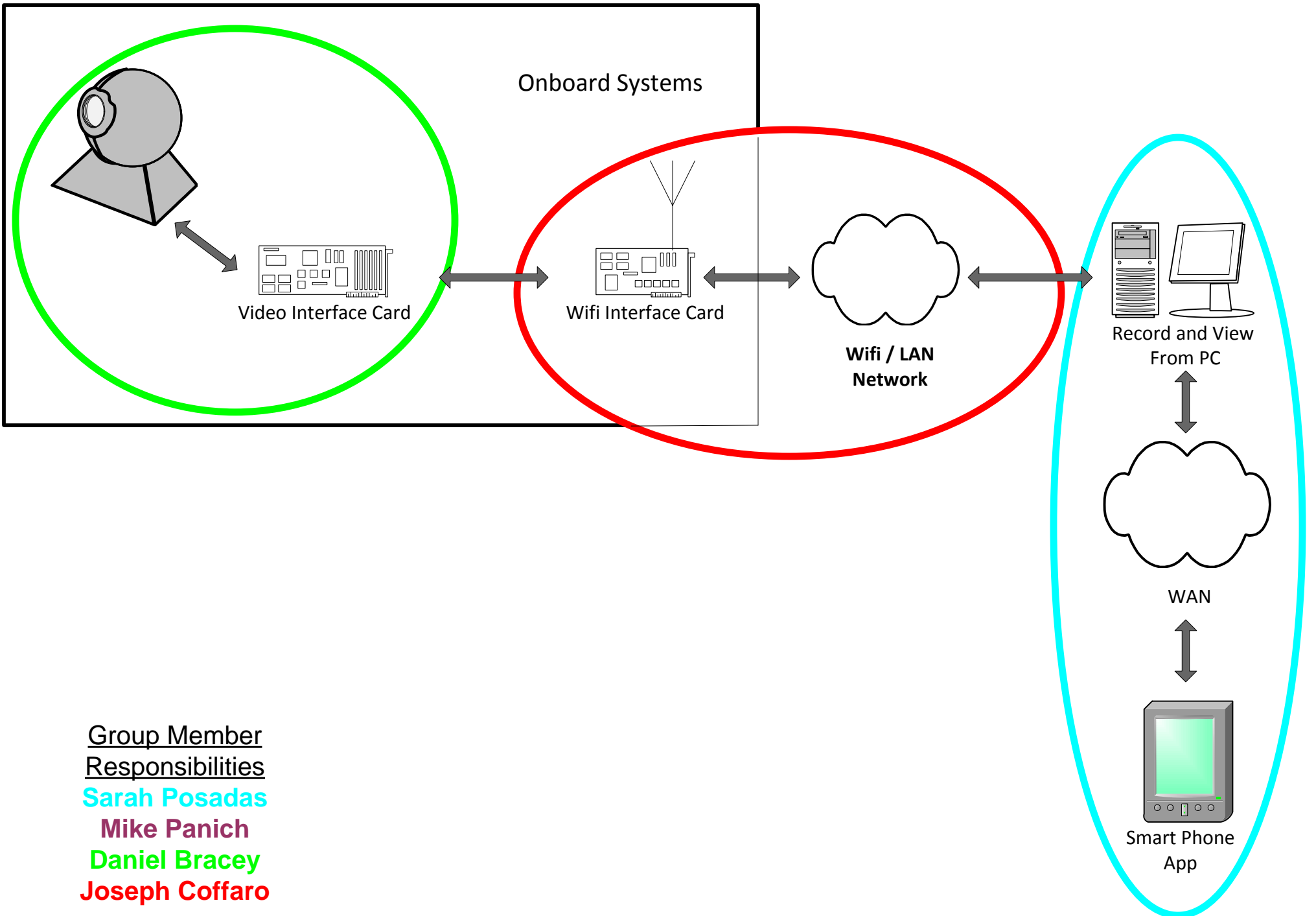

Group Member
Responsibilities

Sarah Posadas

Mike Panich

Daniel Bracey

Joseph Coffaro

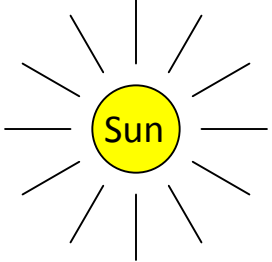

Power Subsystem

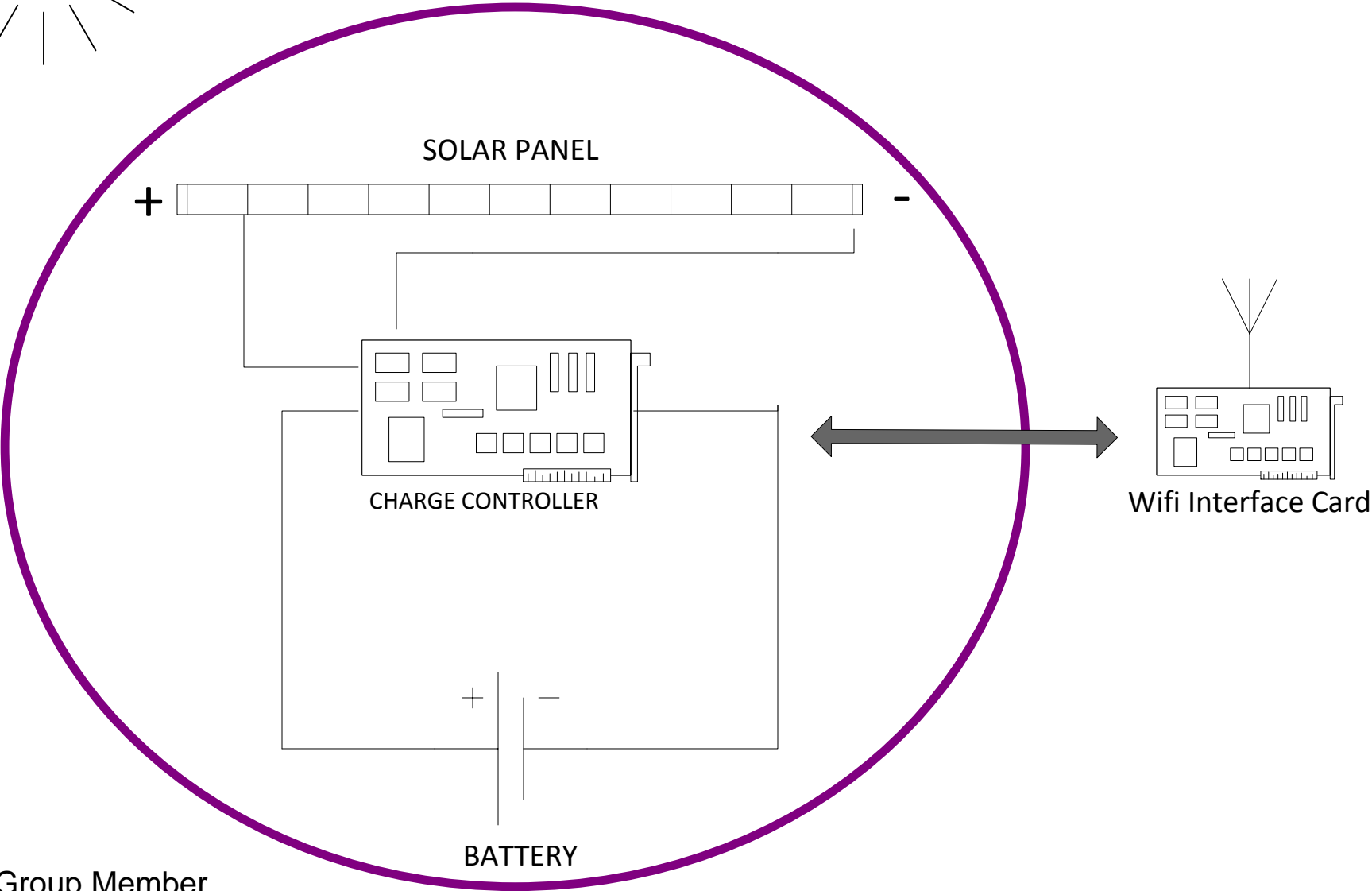

Group Member Responsibilities

Sarah Posadas

Mike Panich

Daniel Bracey

Joseph Coffaro

Remote Monitoring

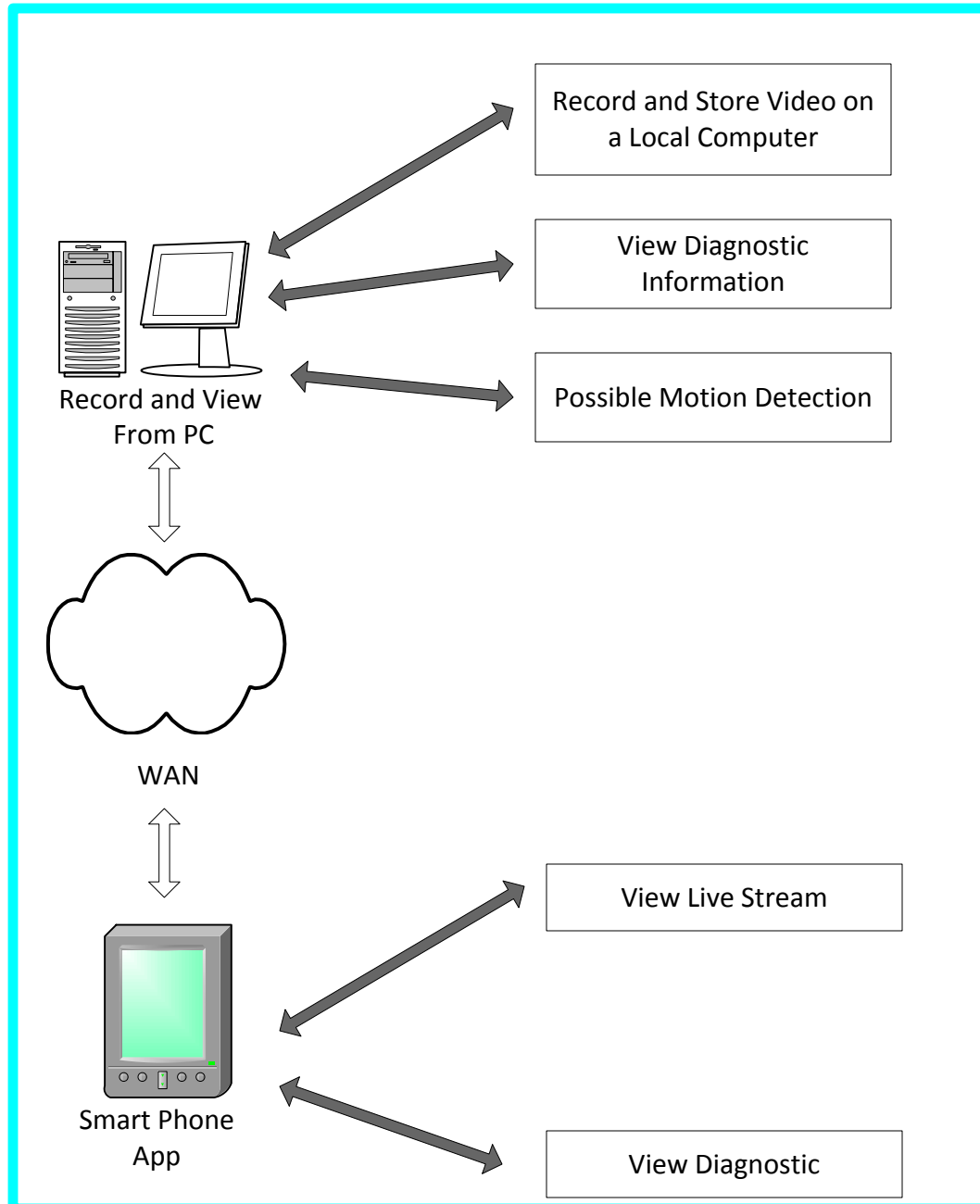

Group Member
Responsibilities

Sarah Posadas

Mike Panich

Daniel Bracey

Joseph Coffaro